



RT510RF THERMOSTAT - FULL USER MANUAL

SALUS
CONTROLS

TABLE OF CONTENTS

1. Introduction	4
1.1 Product Compliance	4
1.2 Safety Informations	4
2. Product Overview	5
2.1 Package content	6
2.2 Proper thermostat location	6
3. RXRT510 receiver	7
3.1 Receiver's switches description	7
3.2 LED indications in the receiver	8
3.3 Wall mounting of the receiver	9
3.4 Connection description	10
4. Before you start (first power up)	11
4.1 LCD icon description	11
4.2 Button description	11
4.3 First power up sequence and configuration	12
5. User settings	13
5.1 Time settings	13
6. Operating modes	14
6.1 Manual mode - changing temperature setpoint	14
6.2 Schedule mode	15
6.3 Temporary override mode	16
6.4 Boost mode (hourly temperature override mode)	16
6.5 Frost protection mode	17
6.6 Holiday mode	17
6.7 Sleep mode	18
6.8 Temperatures outside operating range	19
6.9 Low battery detection	19
6.10 Battery change	19
7. Installer mode	20
7.1 DIP switches parameters	20
8. RT510TX thermostat pairing with the receiver	21
9. Test the pairing process	22
10. Factory Reset	23
11. Cleaning and Maintenance	24
12. Technical Informations	24
13. Warranty	25

1. Introduction

1.1 Product Compliance

This product complies with the essential requirements and other relevant provisions of Directives 2014/53/EU and 2011/65/EU. The full text of the EU Declaration of Conformity is available at the following internet address: www.saluslegal.com.

1.2 Safety Informations

- Before starting installation work and before using the product, read the entire manual.
- The information contained in the instructions is essential for proper functioning.
- To avoid accidents resulting in personal injury and material damage, please follow all safety precautions, specified in this manual.
- The device should not be used by people with limited mental, sensory or mental abilities, without experience, of insufficient knowledge as well as children.
- Do not use an unassembled device (eg without a cover).
- The device may only be opened by a qualified person.
- Keep electrical devices out of the reach of children and ensure that they do not play with it. Children should not be left unattended. If necessary, disconnect the control system for the entire room.
- Do not leave the packaging, cabinet, or any loose parts of the device unattended, as they pose a risk to children.

WARNING!

- Installation must be carried out by a qualified person with appropriate electrical qualifications in accordance with standards and regulations in force in the given country and in the EU.
- Never try to connect the device other than as described in the manual.
- Before assembly, repair or maintenance as well as during any connection works it is absolutely necessary disconnect the mains supply and make sure that the terminals and electric wires are not live.
- The device may not be exposed to extreme temperatures, strong vibrations or subjected to mechanical shock.
- The device should not be used in unfavorable environmental conditions or in rooms where there is a concentration of flammable gases, fumes or dust.

WARNING!

- There may be additional protection requirements for the entire installation that the installer is responsible for maintaining.



Care for the natural environment is of paramount importance to us. The awareness that we manufacture electronic devices obliges us to dispose of used electronic components and devices safely. Therefore the company has received a registration number issued by the Chief Inspector for Environmental Protection. The crossed out symbol the trash can on the product means that the product must not be disposed of with ordinary waste containers. Sorting waste for recycling helps to protect the environment. It is the user's responsibility to surrender used equipment to a designated collection point for recycling waste from electrical and electronic equipment.

2. Product Overview

The RT510RF wireless room thermostat simply switches the heating system on and off as necessary. It works by sensing the air temperature, switching on the heating when the air temperature falls below the thermostat setting, and switching it off once this set temperature has been reached.

Turning a room thermostat to a higher setting will not make the room heat up any faster. How quickly the room heats up depends on the design of the heating system, for example, the size of boiler and radiators. Neither does the setting affect how quickly the room cools down. Turning a room thermostat to a lower setting will result in the room being controlled at a lower temperature, and saves energy.

The heating system will not work if a time switch or programmer has switched it off.

The way to set and use your room thermostat is to find the lowest temperature setting that you are comfortable with, and then leave it alone to do its job. The best way to do this is to set the room thermostat to a low temperature – say 18°C – and then turn it up by one degree each day until you are comfortable with the temperature.

You won't have to adjust the thermostat further. Any adjustment above this setting will waste energy and cost you more money.

If your heating system is a boiler with radiators, there will usually be only one room thermostat to control the whole house. But you can have different temperatures in individual rooms by installing thermostatic radiator valves (TRVs) on individual radiators. If you don't have TRVs, you should choose a temperature that is reasonable for the whole house. If you do have TRVs, you can choose a slightly higher setting to make sure that even the coldest room is comfortable, then prevent any overheating in other rooms by adjusting the TRVs.

Room thermostats need a free flow of air to sense the temperature, so they must not be covered by curtains or blocked by furniture. Nearby electric fires, televisions, wall or table lamps may prevent the thermostat from working properly.

Product advantages:

- set factory-paired and ready to work
- has a TPI control algorithm
- automatically repeats the signal
- works according to time schedules
- has a frost protection mode (temperature range 5 - 17 degrees)
- correction of the displayed temperature $\pm 3^{\circ}\text{C}$
- has a HOLIDAY mode and SLEEP mode (suspending the function, e.g. outside the heating season)
- has unique transmission codes
- operates at 868 MHz - a stable and noiseresistant signal

2.1 Package content

- 1) RT510TX thermostat
- 2) RXRT510 receiver
- 2) 2x AA batteries
- 3) Short instruction
- 4) Mounting screws



2.2 Proper thermostat location

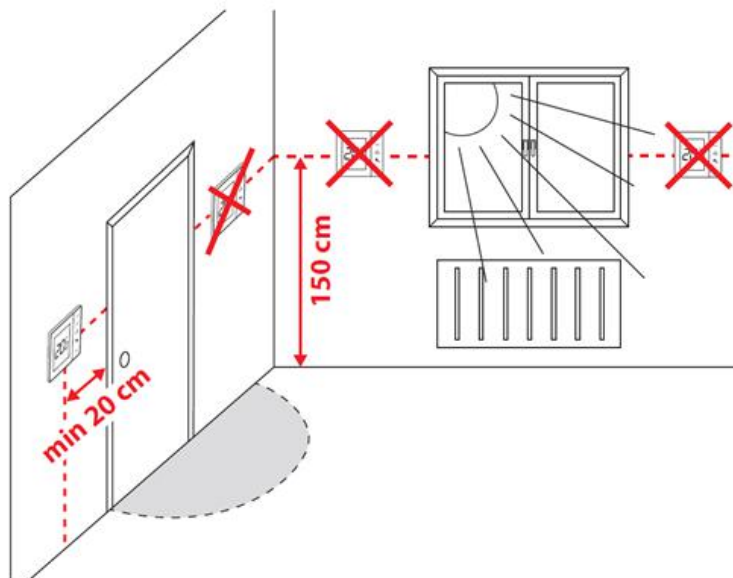

Please note:

The ideal position to thermostat mounting is about 1,5m under floor level far from heating or cooling sources. Thermostat can't be exposed to sunlight or any extreme conditions like for example draft.

Because of fire and explosion risk there is not allowed to use thermostat in atmosphere of explosive gases and flammable liquids (eg coal dust). In case if any of listed dangers occur you have to use additional protection measures – anti-dust and explosive gases (tight cover) or prevent their formation. Furthermore, thermostat can't be used in condensation of water vapor conditions and be exposed to water action.

3. RXRT510 receiver

The thermostat communicates wirelessly with the RXRT510 receiver. The receiver should be supplied with 230VAC, the maximum load of the receiver is 16A. Avoid installing the device in places directly exposed to water, moisture and air condensation. The RXRT510 receiver can operate in two different modes - AUTO (automatic) and MANUAL (manual). To select a specific mode, use the switches on the front of the receiver.



3.1 Receiver's switches description



TOP SWITCH	
1.	ON - Manual mode - receiver ON
2.	OFF - Manual mode - receiver OFF
BOTTOM SWITCH	
3.	AUTO - Receiver works in AUTO mode (according to the thermostat's command)
4.	MANUAL - Receiver works in manual mode (according to the top switch)



For the receiver to work with the thermostat, set the switches to the ON / AUTO position.

3.2 LED indications in the receiver

The status of the RXRT510 receiver is indicated by two LEDs. These are LEDs with the following colors:

- 1** - red (upper one),
- 2** - green (lower one).



A detailed explanation of the meaning of the LEDs can be found in the table below:

	DESCRIPTION
The red LED lights up	<p>The receiver is connected to the 230V power supply and is paired with the thermostat.</p> <p>The receiver can be thermostat-enabled if it is in automatic mode when the lower switch is in the AUTO position.</p> <p>The receiver can be started manually when the lower switch is in the MANUAL position.</p>
The red LED flashes	<p>The receiver is in the pairing mode and is looking for a signal from the thermostat (then you must activate the "PAIRING" option in the thermostat)</p> <p>(or)</p> <p>The receiver was paired but lost communication with the thermostat due to out of range or low battery in the thermostat. The receiver starts flashing after one hour of time when it does not receive a signal from the thermostat.</p>
The red diode is off	<p>The receiver is disconnected from the 230V power supply or the upper switch is in the OFF position.</p>
The green diode lights up	<p>In automatic mode, the receiver received a heating signal from the thermostat.</p> <p>The receiver was started in manual mode (upper ON switch, lower MANUAL switch)</p>
The green diode is off	<p>The receiver does not send a heating signal.</p>

3.3 Wall mounting of the receiver

Wall mounting the receiver: drill two $\varnothing 6$ mm holes in the wall. Insert the plugs and, by putting the plate to the wall (included in the set), put the two screws through the holes and then screw them in. Connect the necessary cables to the receiver. Next, hang the receiver on the board using the handles designed in the receiver, marked in the picture below.



1
Loosen the screws with a screwdriver just enough to tilt the back housing.



2
Tilt the receiver cover upwards (according to the position of the „hinge”).

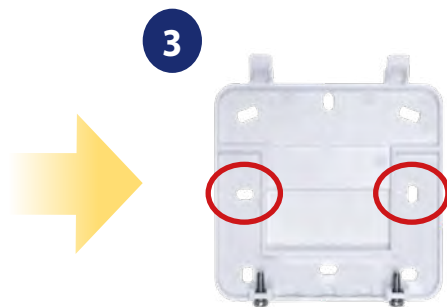

3
Attach the back housing to the wall (keeping the correct positioning of the plastic „hinges”) using the marked holes (see the picture above).

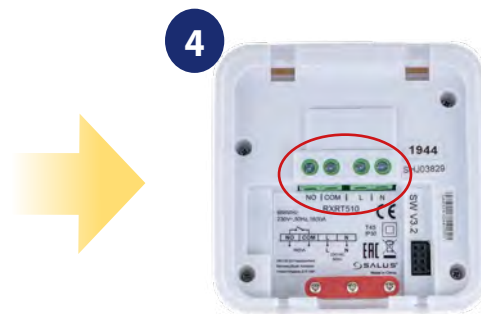

4
Then, correctly connect the wires with the receiver (see „connection diagrams” on page 9).

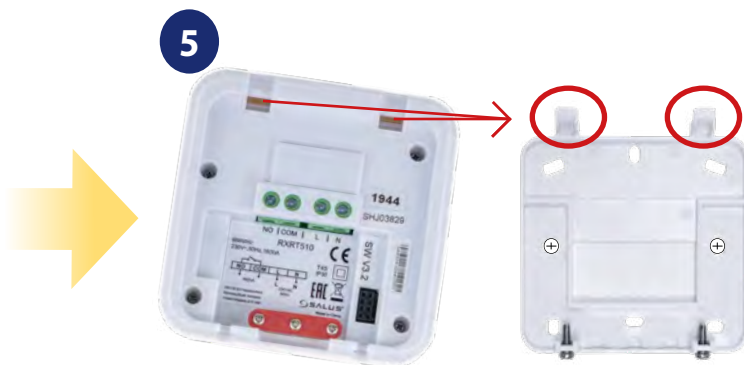

5
Put the receiver from above on the back housing attached to the wall, according to the position of the plastic „hinges”.

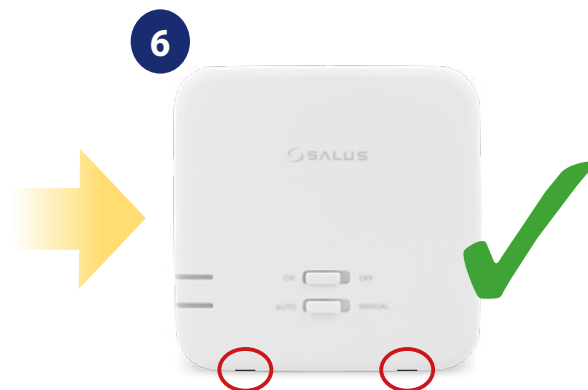

6
Tighten the screws from the bottom of the back housing to the receiver so that it is snug.

3.4 Connection description

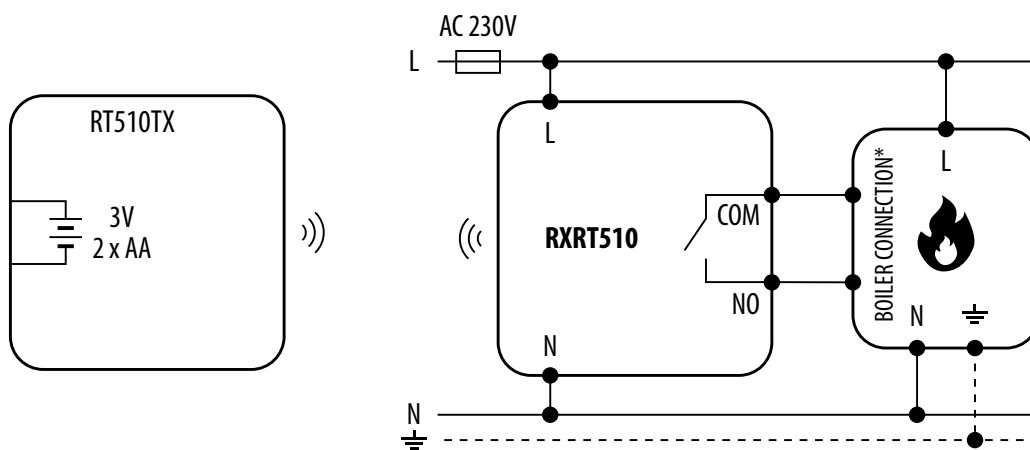

or

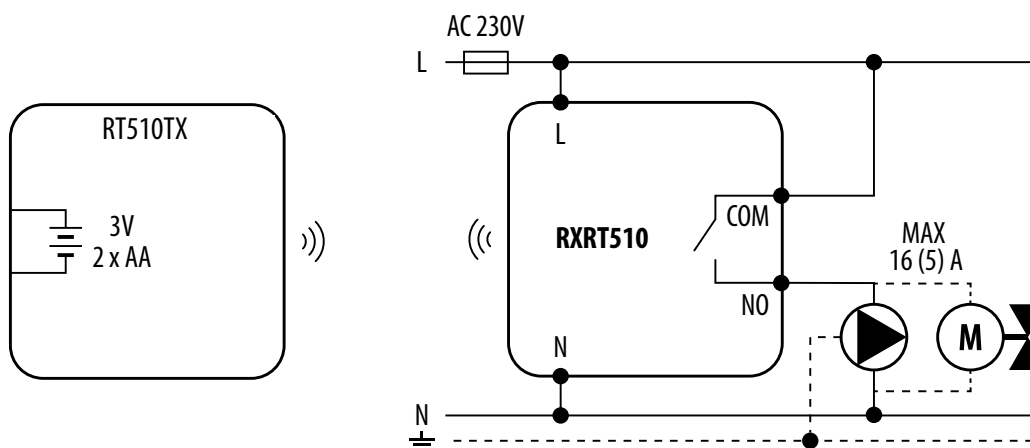

Legend:



Boiler - Boiler connection*
- Boiler's contacts for ON/OFF thermostat (according to the boiler's instructions)



Pump



Valve actuator

Symbols explanation:

L, N - power supply 230V

COM, NO - voltage-free output

- fuse

4. Before you start (first power up)

4.1 LCD icon description

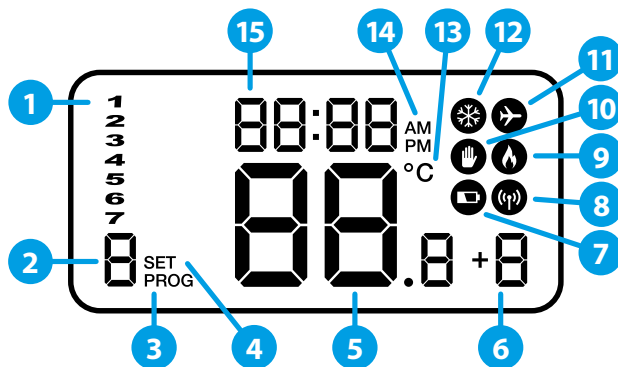

- | | |
|--|------------------------------|
| 1. Day of the week | 9. Heating Mode On |
| 2. Program number | 10. Manual Mode On |
| 3. Program indicator | 11. Holiday Mode On |
| 4. Settings | 12. Frost Protection Mode On |
| 5. Temperature measured / set | 13. Temperature unit |
| 6. Boost function | 14. AM / PM |
| 7. Low battery status | 15. Clock |
| 8. Wireless connection with the receiver | |

4.2 Button description



- | | |
|------------------------------------|--------------------|
| 1. Boost function | 4. Increase button |
| 2. Manual Mode | 5. Decrease button |
| 3. Frost protection / Holiday Mode | |



PLEASE NOTE! The LCD screen can be activated by using any button.

4.3 First power up sequence and configuration

To power up the thermostat you have to put the batteries inside. Then thermostat will display following sequence:

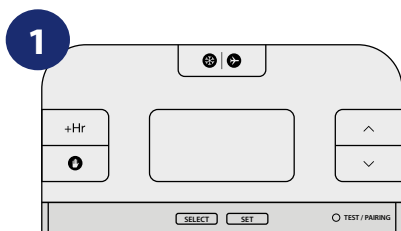

Remove the protection foil and insert 2xAA batteries by removing front cover.

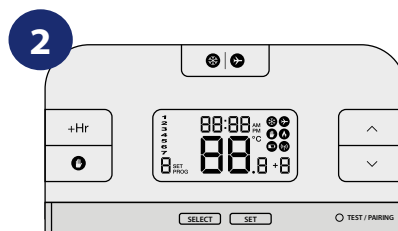

After that, thermostat will automatically power up and it will display all icons...

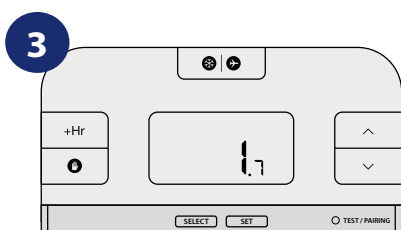

...then thermostat will display the software version.

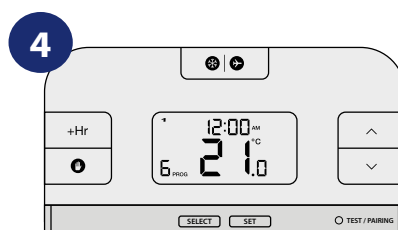

When thermostat is successfully powered up, main screen will be displayed.

5. User settings

5.1 Time settings

In this chapter you can set time and day of the week. RT510TX thermostat has no date settings. You can choose the day of the week (from monday to sunday). Please follow the steps below:

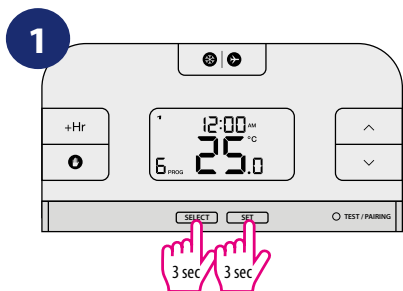

Press the buttons SELECT and SET together for 3 sec to enter the time settings.

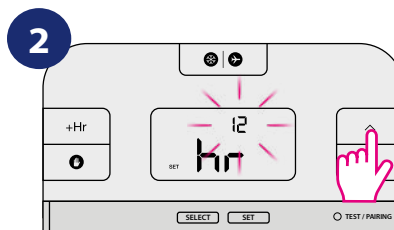

Press ^ or v to select the hour format.

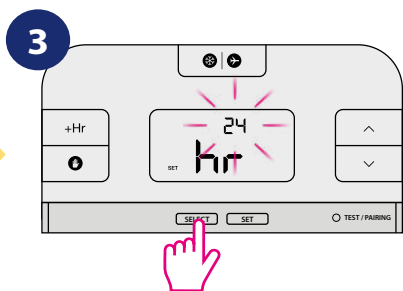

Press SELECT to confirm.

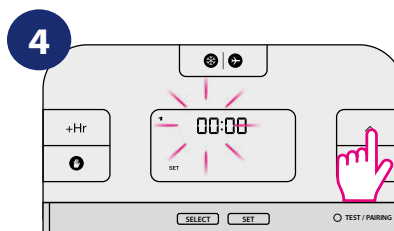

Press ^ or v to set the hour.

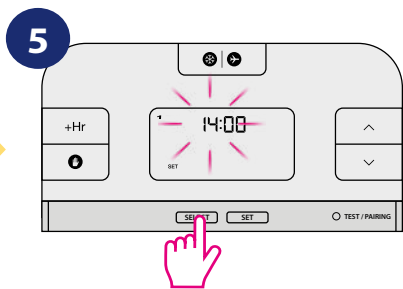

Press SELECT to confirm.

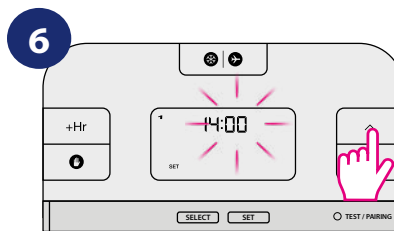

Press ^ or v to set the minutes.

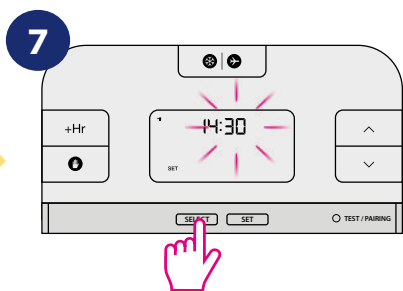

Press SELECT to confirm.

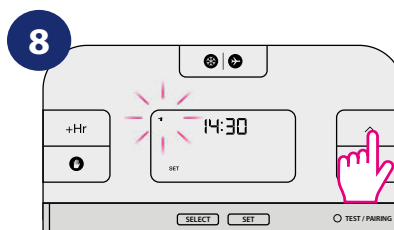

Press ^ or v to set day of the week.

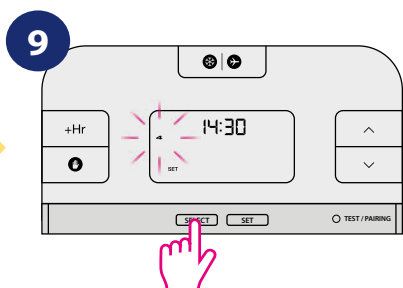

Press SELECT to confirm.

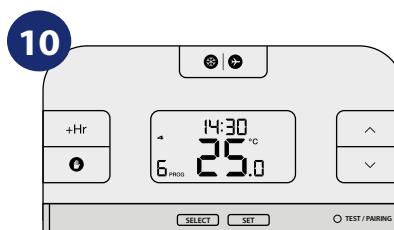

Time settings has been saved. Thermostat will return to the main screen.

6. Operating modes

RT510TX thermostat offers few operating modes:

- **Manual mode** - temperature setpoint is set by user manually and it's maintained until user change the setpoint again or switch to another mode.
- **Schedule mode** - thermostat works according to set schedule by user. It can be programmed in 5+2 (MON to FRI and weekend separately) mode or daily (every day of the week separately) mode.
- **Temporary override mode** - thermostat temporary overwrite programmed schedule and maintain the temperature until next program change (you can use it only during active schedule mode).
- **Boost mode (hourly temperature override mode)** - this option override the temperature setpoint for selected hours. It is available for manual and schedule mode.
- **Frost protection mode** - thermostat maintain constant frost protection temperature until user exit this mode. Thermostat work on the lowest level and takes as little energy as possible.
- **Sleep mode** - thermostat is basically switched off and takes no energy. You can turn it on by any button.
- **Holiday mode** - user can program day period to make thermostat maintain frost protection temperature. It is mostly when user go somewhere outside for a long time eg. holidays and doesn't want thermostat to take bigger amount of energy.

6.1 Manual mode - changing temperature setpoint

In manual mode, the thermostat maintains a constant temperature set by the user. To set temperature setpoint follow steps below:

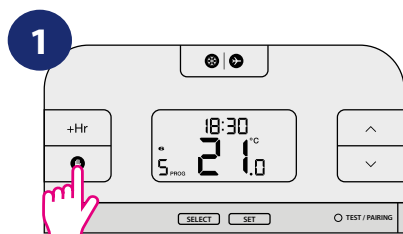

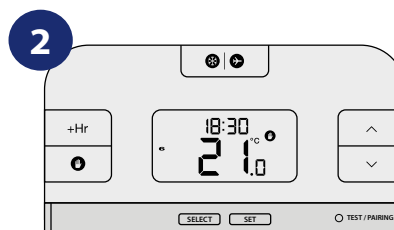

Press  button to activate the Manual Mode.

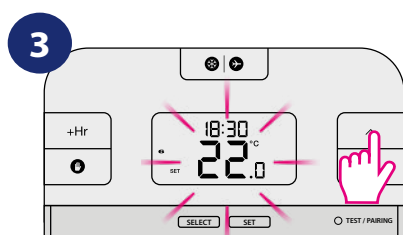

Hand icon will appear on the main screen.



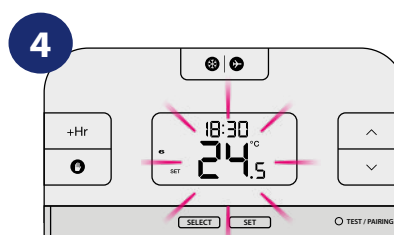

Using  or  buttons set new setpoint temperature.



After new setpoint temperature set, thermostat will return to the main screen and will work in manual mode.



To turn off the Manual Mode press  button. Once the manual mode is off, the hand icon  on the thermostat will disappear.

6.2 Schedule mode

In this mode, user can set the schedules for thermostat (temperature setpoints for specific periods of time). There are two types of schedules: 5/2 (working days+weekends) and 7d (7 individual schedules for each day separately). Schedule type can be chosen by parameter d04 (please refer to Installer mode section). Schedule is divided by 6 time programs (which means user can have maximum of 6 temperature changes during a day). To program a schedule its necessary to fill in all 6 programs. To set schedule please follow steps below:

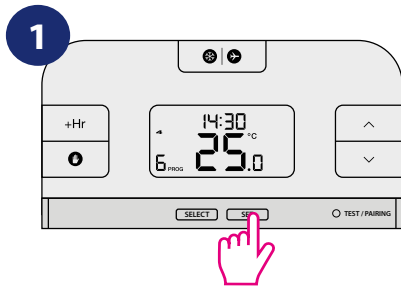

Press the SET button to start programming.

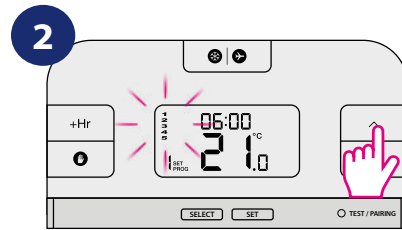

Use the ^ or v button to select day / days from which you want to start programming.

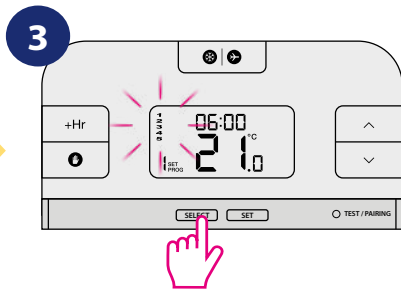

Press SELECT to confirm.

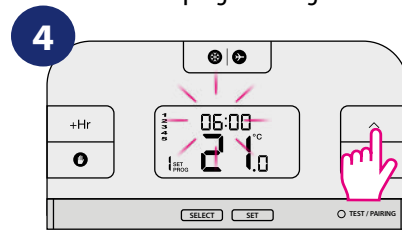

Use the ^ or v button to set the hour for the program #1.

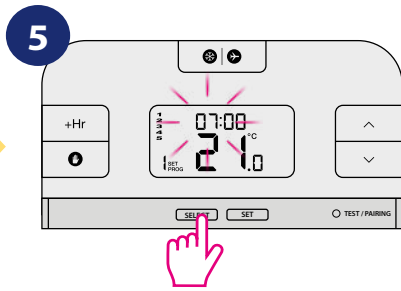

Press SELECT to confirm.

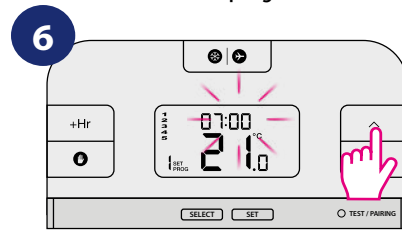

Use the ^ or v button to set the minutes for the program #1.

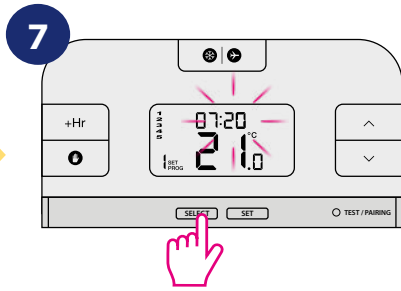

Press SELECT to confirm.

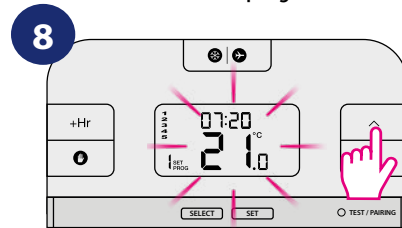

Use the ^ or v button to set the temperature for the program #1.

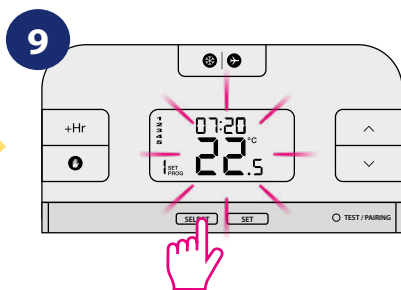

Press SELECT to confirm.

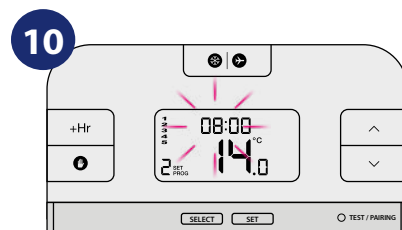

Follow steps 4-9, to define programs 2-6. Press SET button at the end of programming to confirm and save all the settings.

6.3 Temporary override mode

This function is available only in schedule mode (AUTO). If a new setpoint temperature will be set during the schedule - it will be maintained until next time interval starts according to programmed schedule.

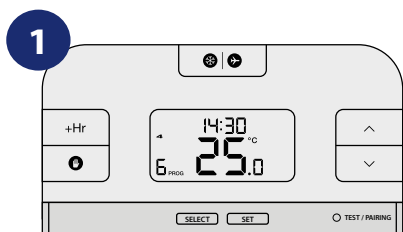

Using \wedge or \vee buttons set new setpoint temperature during active schedule.

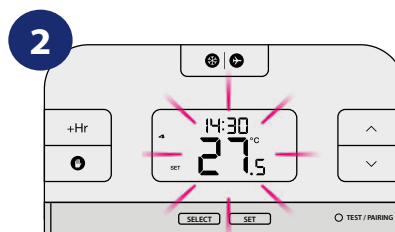

After new setpoint temperature set, thermostat will return to the main screen and it will temporary override the schedule.



Temporary Override mode will be disabled when new schedule will be set.

6.4 Boost mode (hourly temperature override mode)

This function is available in schedule and manual mode. It is used to change the setpoint temperature for a specified number of hours (up to 9 hours). Once that time is over, thermostat returns to previous mode. To set this mode please follow steps below:

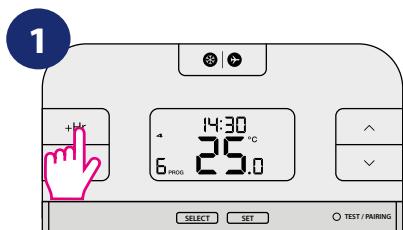

Press +Hr button to set number of hours for temperature override (e.g. to set up override for 3 hours, press the button 3 times).

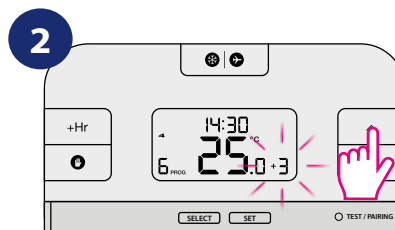

Using \wedge or \vee button set a new setpoint temperature for hourly temperature override mode.

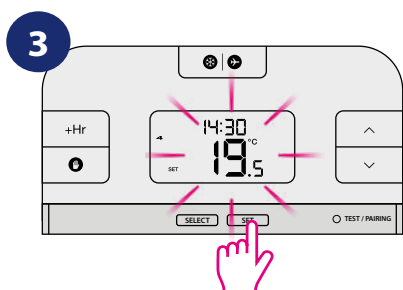

Press SET button to confirm.

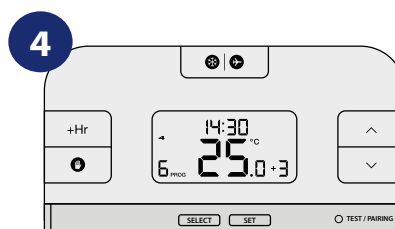

Thermostat will work for the set period of hours. After that it will switch back to the previous mode.



To turn off hourly temperature override mode before time's up, press the + Hr button until number of hours disappears from display.

6.5 Frost protection mode

In this mode the setpoint temperature is automatically set to frost setpoint to prevent pipes from frosting. If the room temperature is lower than the frost setpoint, frost protection will be enabled. To set frost protection mode follow steps below:

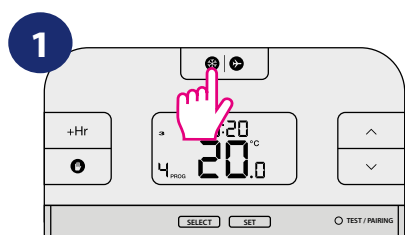

Press button to turn ON/OFF frost protection.

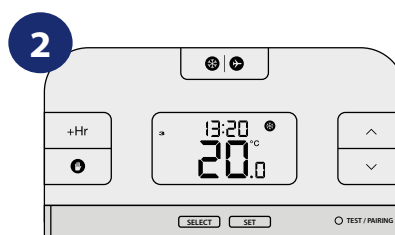

Snowflake icon will be displayed if frost protection is active.

The Frostpoint temperature can be reviewed by pressing the UP button once, but can only be changed in Installer Mode.

6.6 Holiday mode

In this mode the “frost protection” temperature is maintained for a specific number of days. To set the holiday mode please follow steps below:

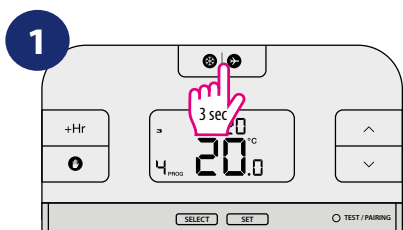

Hold down button for 3 seconds to activate the holiday mode.

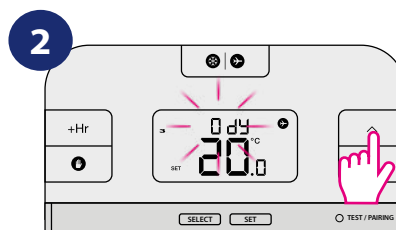

Use or button to set the number of days for holiday mode.

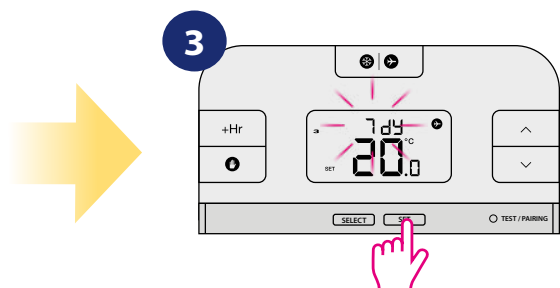

Press SET button to confirm.
You can set up to 31 days.

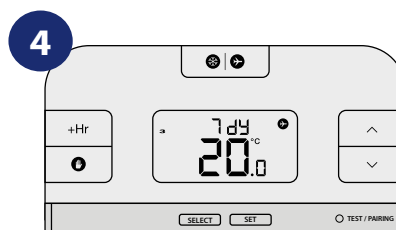

Thermostat is working in holiday mode. Number of days left and airplane icon will appear on the main screen.

To turn off the Holiday Mode, hold down button for 3 seconds. The airplane icon should disappear from the display.

6.7 Sleep mode

In sleep mode thermostat stay in frost protection temperature but it is switched off and doesn't consume any energy and it is impossible to make an action until you activate the thermostat again. To activate/deactivate sleep mode follow steps below:

TO ACTIVATE SLEEP MODE:

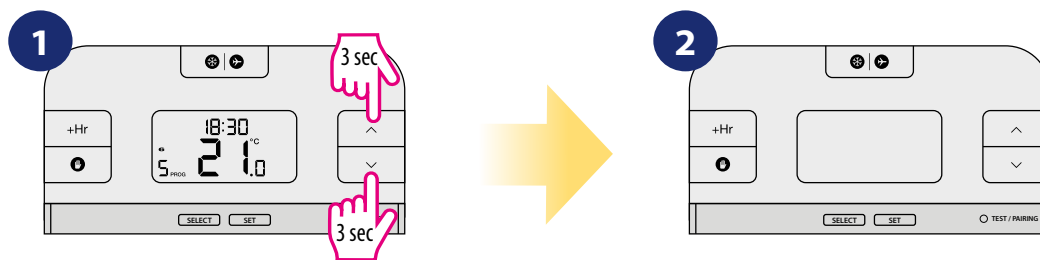

Press and hold ^ + v buttons simultaneously to turn ON sleep mode.

In sleep mode thermostat is displaying nothing.

TO DEACTIVATE SLEEP MODE:

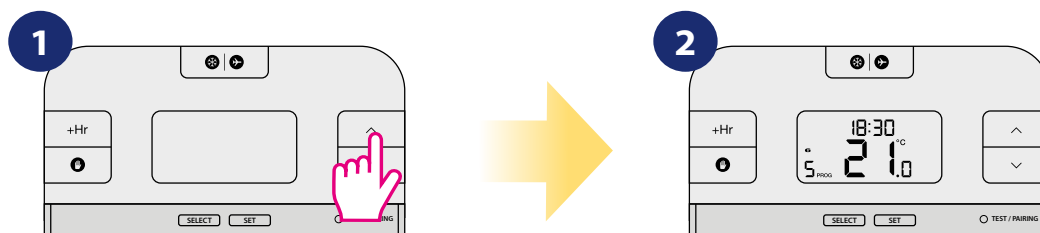

To deactivate sleep mode press any button.

Thermostat will go back to previous mode and display main screen.

6.8 Temperatures outside operating range

Temperatures below 10 °C are displayed without the leading '0'. Temperatures exceeding the measurable range will be indicated by 'HI' for temperatures above the upper limit, and 'LO' for temperatures below the lower limit, as shown in the images.



6.9 Low battery detection

Battery voltage is checked every minute. When the battery voltage drops to a certain level, the Low-Battery warning  indicator appears.

- The thermostat functions normally during low battery. However, user must change the batteries as soon as possible before the battery is too weak for the normal operation to be assured.
- When you change the batteries, you have about 30 seconds to do so without losing your settings.

6.10 Battery change

When you want to change the batteries your device will use the internal memory to backup your settings. You have 30 seconds to change the batteries before losing your settings. To change batteries please follow steps below:

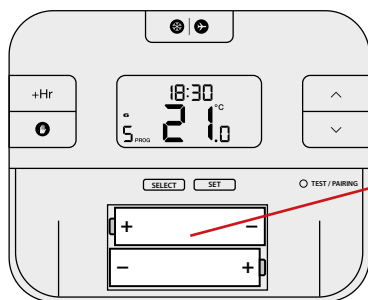

Remove the batteries without pressing any button and insert the new ones according to the polarity

7. Installer mode

To enter installer parameters please follow steps below. Please refer to parameters table description before any changes. Use \wedge or \vee buttons to move up or down between all parameters. Every change/selection confirm by \otimes button.

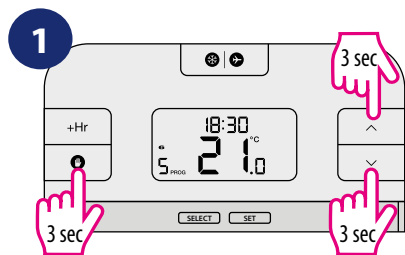

Press and hold $\otimes + \wedge + \vee$ simultaneously for about 3 seconds to enter the installer mode.

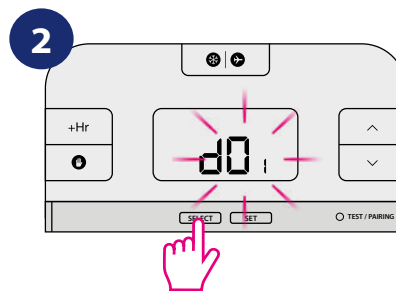

Use SELECT button to choose parameter, confirm selection by SET button. To change parameter value use \wedge or \vee buttons and confirm selection by SET button. To exit the installer mode, wait 10 seconds - thermostat will re-turn automatically to the main screen.

DETAILED TABLE WITH ALL INSTALLER PARAMETERS:

dxx	Function	Parameter	Default value
d01	Temperature display increments	0.1°C or 0.5°C	0.5°C
d02	Temperature offset	+/- 3.0°C	0.0°C
d03	Frost Protection setpoint temperature	5.0°C - 17.0°C	5.0°C
d04	Programmer selection	5/2 or 24 hr (7d)	5/2 d

7.1 DIP switches parameters

DIP switched are used to set chosen control algorithm. They are under back cover of the thermostat (please refer to the picture below):

Type of control	TPI	Hysteresis
How it works	When TPI is selected on DIP switch № 2, the DIP switch № 1 is functional. You can choose the Cycles Per Hour between a lower comfort level (6CPH) and a higher comfort level (9CPH).	When Span is selected on DIP switch № 2, the DIP switch № 1 is not functional. The SPAN value is set to $\pm 0.25^\circ\text{C}$ - it is recommended to use with heating devices.

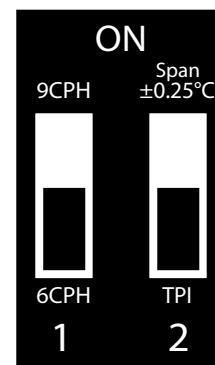

8. RT510TX thermostat pairing with the receiver

The word PAIRING in the user settings means the function of synchronizing the transmitter with the receiver again, if it has been removed.



WARNING!

IN THE SET RT510RF THE THERMOSTAT IS FACTORY PAIRED WITH THE RECEIVER!

In order to pair the devices correctly, you must first prepare the receiver for synchronization!

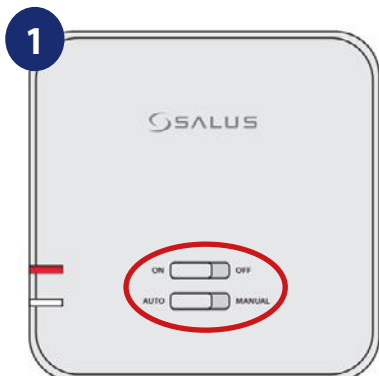

If you want to re-pair the devices with each other, make sure that the receiver is disconnected from the power supply and the switches on it are in the AUTO and ON positions. Then connect the receiver to the power supply and wait for the red diode to glow continuously.

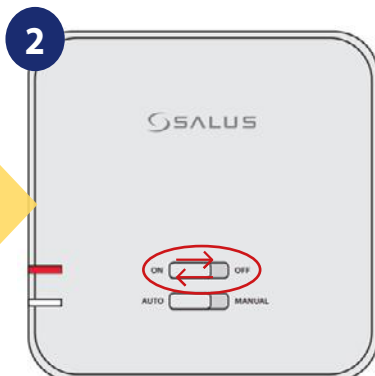

Move the top switch to the OFF position with a quick motion and back to the ON position.

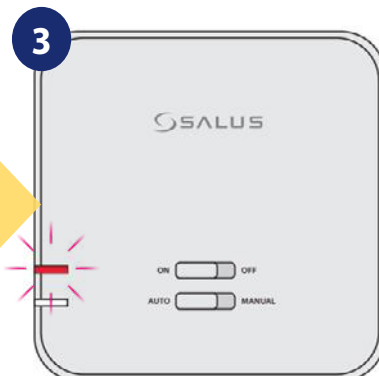

The red LED will start blinking, which will confirm that the receiver has entered the pairing mode.

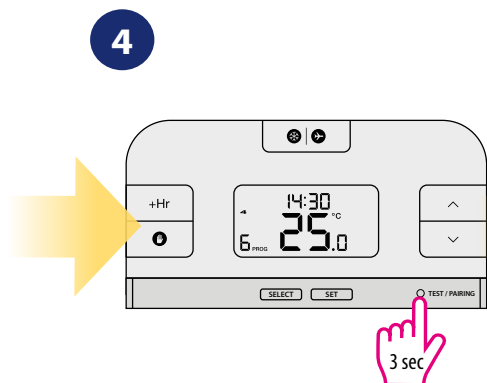

Press and hold TEST / PAIRING button for 3 seconds.

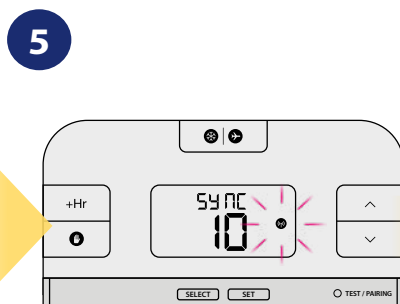

Thermostat started pairing process. It can take up to 10 minutes.

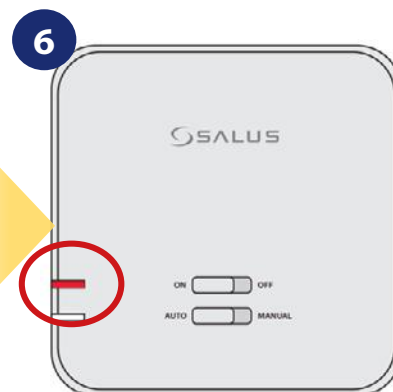

When the red diode on the receiver lights up continuously, the devices have been paired on a new frequency.

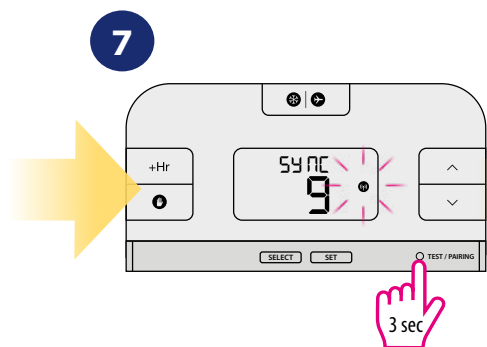

Press and hold TEST / PAIRING button for 3 seconds to end pairing process.

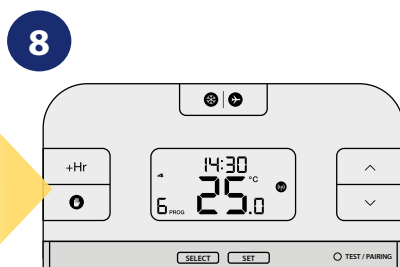

Thermostat will go back to the main screen and it has been paired successfully.

9. Test the pairing process

It is important to place the receiver and transmitter in places where nothing interferes with the radio signal. The range of communication between the transmitter and the receiver in an open area is up to 60m. The radio transmission is influenced by many factors that can shorten the working distance, such as thick walls, drywall covered with aluminum foil, metal objects such as cabinets, general radio interference, etc. However, the range is sufficient for most domestic use. It is recommended to test the radio transmission between devices before mounting the regulator on the wall. The test can be performed by changing the set temperature, i.e. by activating or deactivating the heating.

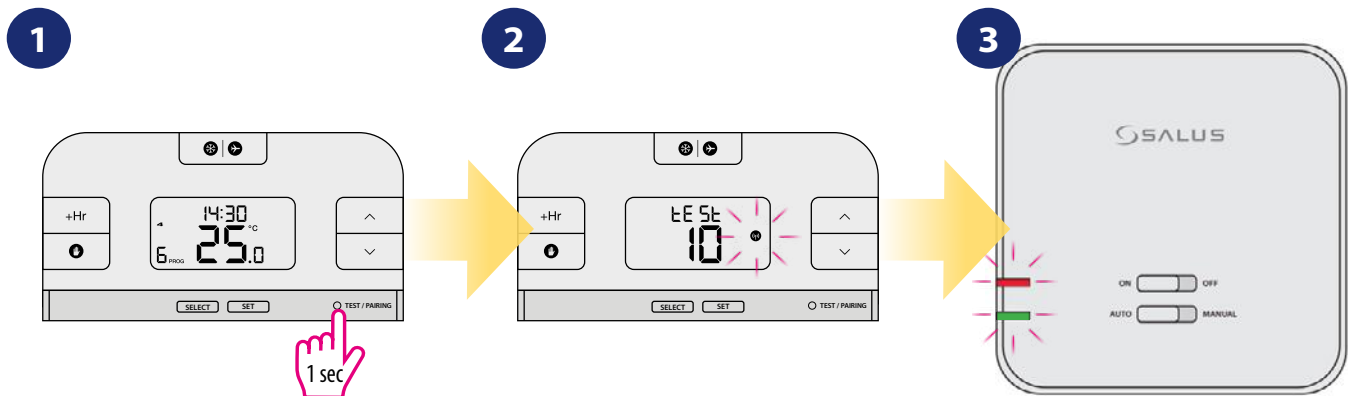

Press TEST / PAIRING button to check the connection with the receiver.

Antenna icon will display. Test mode can take up to 9 minutes.

The red LED and the green LED on the receiver will begin to flash.

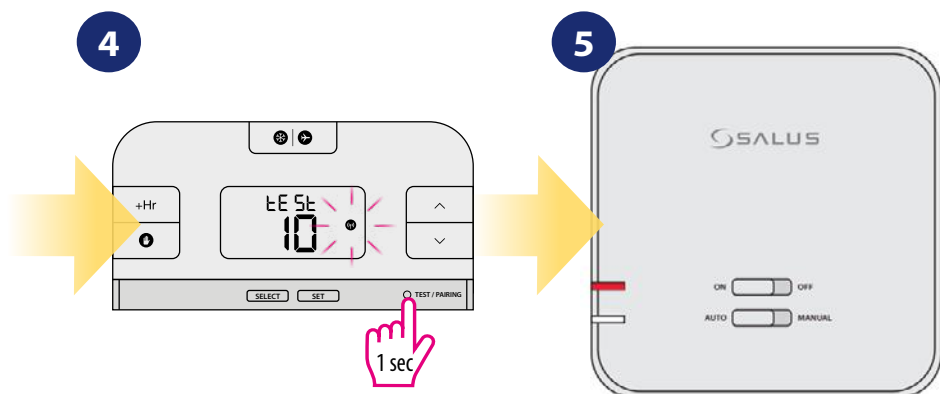

Press TEST / PAIRING button again to return to the main screen.

Receiver will go back to normal work mode.



If you purchased an RXRT510 or RT510TX and intend pairing with other devices in the 5x5 range, please refer to the Receiver Units manual or the relevant manuals available at www.salus-controls.eu

10. Factory Reset

To RESET RT510TX thermostat to it's factory default settings please follow steps below:

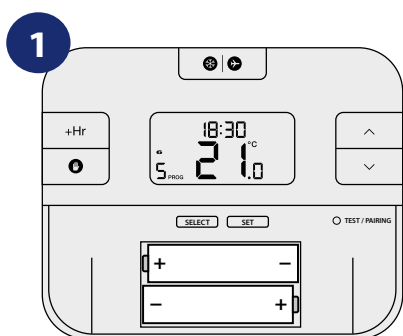

When you want to change the batteries your device will use the internal memory to backup your settings. You have 30 seconds to change the batteries before losing your settings.

Remove the batteries without pressing any button. Wait 2 minutes and insert the batteries again. Your device will be restarted.

11. Cleaning and Maintenance

The **RT510TX thermostat** requires no special maintenance. Periodically, the outer casing can be wiped clean using a dry cloth (please **DO NOT** use solvents, polishes, detergents or abrasive cleaners, as these can damage the thermostat). There are no user serviceable parts within the unit; any servicing or repairs could only be carried out by **Salus Controls** or their appointed agents.

12. Technical Informations

Transmitter's power supply	2 x AA batteries
Receiver's power supply	230V AC 50 Hz
Rating max	16 (5) A
Output signal	NO/COM relay
Temperature range	5 - 35°C
Display temperature accuracy	0.1°C or 0.5°C
Control algorithm	TPI or Hysteresis: $\pm 0.25^\circ\text{C}$
Communication	Wireless, 868Mhz
Dimension [mm]	transmitter: 120 x 96 x 27 receiver: 96 x 96 x 27

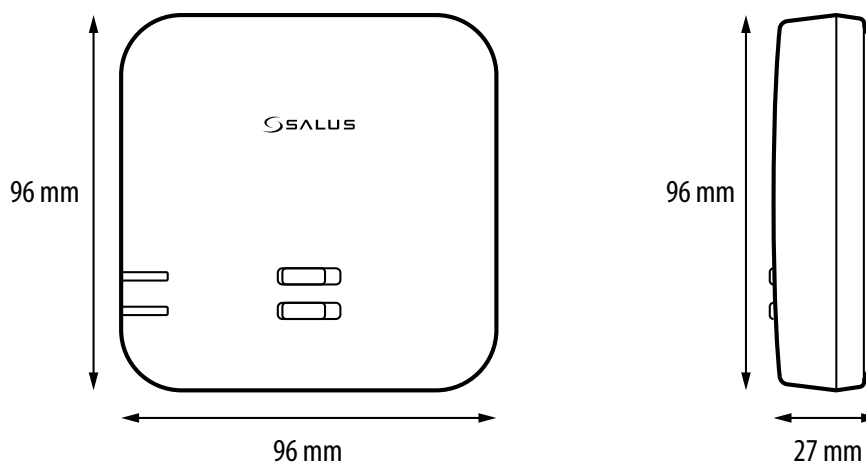
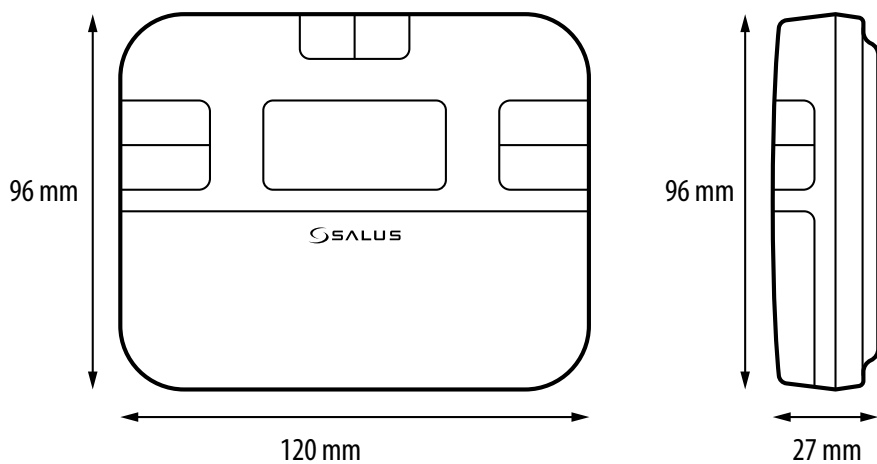

13. Warranty

SALUS CONTROLS warrants this product to be free from any defects in material or workmanship and to perform as specified for a period of five years from the date of installation. SALUS CONTROLS reserves the sole responsibility for breach of this warranty by repairing or replacing the defective product. This product includes software that matches the distributor's identification at the time of sale. The manufacturer / distributor provides a guarantee covering all functions and specifics of the product in accordance with this marking. The distributor's warranty does not cover the correct operation of the functions and features available as a result of a product software update.

The full warranty conditions are available at www.salus-controls.eu

Customer Name:	
Customer Address:	
..... Post Code:	
Tel No: Email:	
Company Name:	
Tel No: Email:	
Installation Date:	
Installer Name:	
Installer Signature:	

IMPORTER:

QL CONTROLS Sp. z o.o. Sp. k.
ul. Rolna 4, 43-262 Kobielice

PRODUCER:

Salus Limited
6/F, Building 20E, Phase 3, Hong Kong Science
Park, 20 Science Park East Avenue, Shatin,
New Territories, Hong Kong



www.salus-controls.com

SALUS Controls is a member of the Computime Group.

Maintaining a policy of continuous product development SALUS Controls plc reserve the right to change specification, design and materials of products listed in this brochure without prior notice.

Ver. 2

Issued: 29 III 2020

Soft version: 1.7

